

Light Receptacle



ON



OFF

SYSTEM FUSE

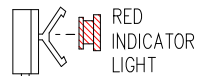

PUMP 1 FUSE

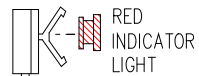

PUMP 2 FUSE

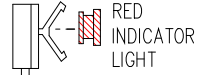

AIR BLOWER FUSE

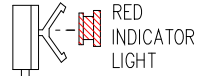

OZONATOR FUSE

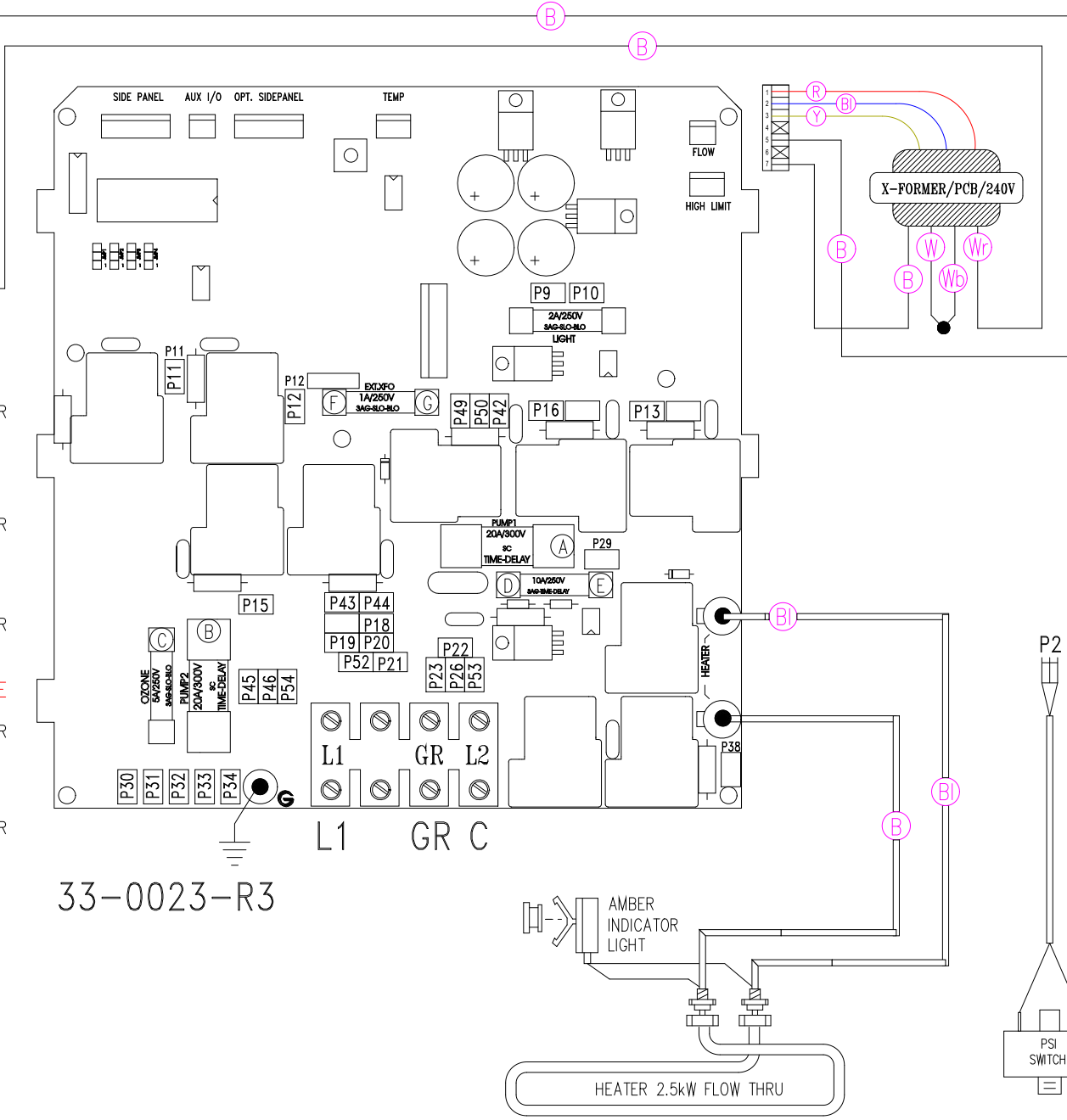
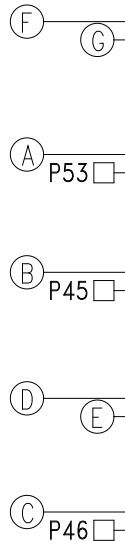
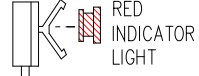

33-0023-R3

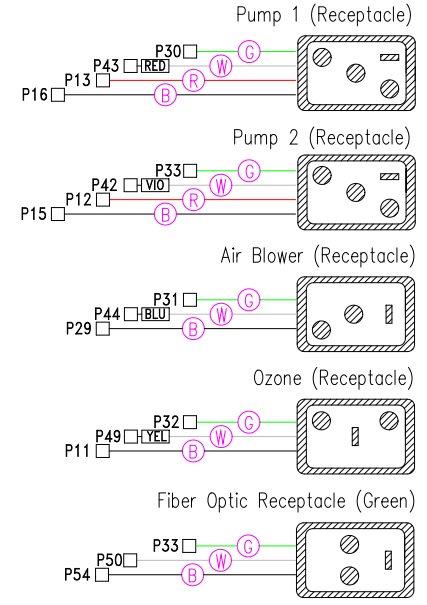

LEGEND	
	- 1/4" QUICK CONNECT
	- 1/4" PIGGYBACK
	- FORK CONNECTOR
	- RING CONNECTOR
	- SOCKET CONNECTOR
	- PIN CONNECTOR

HYDRO-QUIP
CORONA, CA (909) 273-7575

Manufacture Notes:

Approved By:

Dwg. No. **H222A0-KPQY8-B**
Sheet Metal P/N: **65-0221**

Drawn BH
Date 09.22.03
Diagram No. **4304**

Wire Color Code	
B - Black	G - Green
Br - Brown	Bl - Blue
R - Red	V - Violet
O - Orange	W - White
Y - Yellow	Gr - Gray